

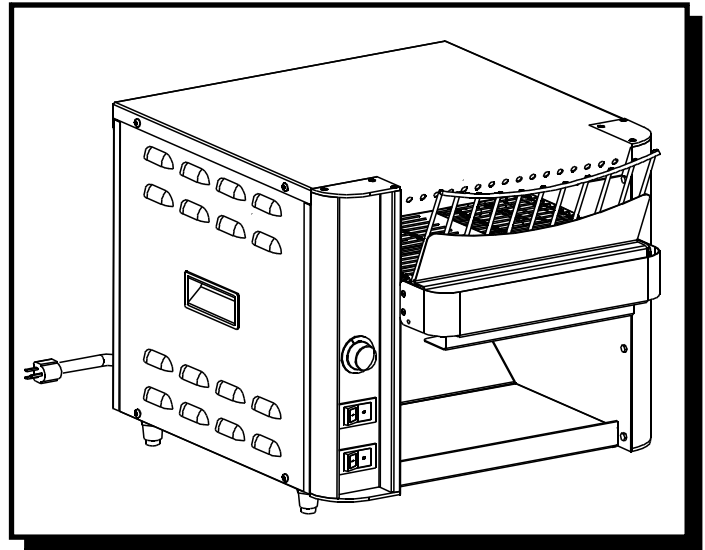

**INSTALLATION
AND
OPERATING INSTRUCTIONS**



XPRS TOASTER

**INTENDED FOR OTHER
THAN HOUSEHOLD USE**

Model: **XPRS**

**RETAIN THIS MANUAL FOR FUTURE REFERENCE
APPLIANCE MUST BE KEPT CLEAR OF COMBUSTIBLES AT ALL TIMES**



FOR YOUR SAFETY: Do not store or use gasoline or other flammable vapors and liquids in the vicinity of this or any other appliance.



WARNING: Improper installation, adjustment, alteration, service or maintenance can cause property damage, injury or death. Read the Installation, Operating and Maintenance Instructions thoroughly before installing or servicing this equipment.



Initial heating of appliance may generate smoke or fumes and must be done in a well ventilated area. Overexposure to smoke or fumes may cause nausea or dizziness.

This equipment has been engineered to provide you with year-round dependable service when used according to the instructions in this manual and standard commercial kitchen practices.



ANSI/NSF4

Phone: +1 (214) 421-7366
Fax: +1 (214) 565-0976
Toll Free: +1 (800) 527-2100
Website: www.apwwyott.com
E-mail: info@apwwyott.com

(800) 733-2203
24 Hour Service Hotline

APW WYOTT
729 Third Avenue
Dallas, TX 75226

P/N 93100174 9/06

SAFETY PRECAUTIONS

Before installing and operating this equipment be sure everyone involved in its operation are fully trained and are aware of all precautions. Accidents and problems can result by a failure to follow fundamental rules and precautions.

The following words and symbols, found in this manual, alert you to hazards to the operator, service personnel or the equipment. The words are defined as follows:















 DANGER: This symbol warns of imminent hazard which will result in serious injury or death. 
 WARNING: This symbol refers to a potential hazard or unsafe practice, which could result in serious injury or death. 
 CAUTION: This symbol refers to a potential hazard or unsafe practice, which may result in minor or moderate injury or product or property damage. 
 NOTICE: This symbol refers to information that needs special attention or must be fully understood even though not dangerous. 

TABLE OF CONTENTS

SECTION	ITEM	PAGE
1	Important Safety Instructions	3
2	General Information	5
3	Installation Instructions	5
4	Operation Instructions	5
5	Cleaning Instructions	6
6	Specifications	6
7	Troubleshooting	7
8	Parts List with Exploded View	8
9	Wiring Diagram	10
10	Warranty	11

1. IMPORTANT SAFETY INSTRUCTIONS

 IMPORTANT: Read the following important safety instructions to avoid personal injury or death, and to avoid damage to the equipment or property. 
 WARNING: APW Wyott toasters are designed, built, and sold for commercial use. If positioned where the general public can use them, make sure that all cautions, warnings, and operating instructions are clearly posted near each unit to insure proper operation, reduce the chance of personal injury and/or equipment damage. 
 WARNING: Plug unit into a properly grounded electrical outlet of the correct voltage, size and plug configuration. If the plug and receptacle do not match, contact a qualified electrician to determine the proper voltage and size and install the proper electrical outlet. 

WARNING: To avoid any injury, turn the power switch off at the fuse disconnect switch/circuit breaker or unplug the unit from the power source and allow to cool completely before performing any maintenance or cleaning.

WARNING: To avoid electrical shock, always unplug the unit before performing cleaning or maintenance.

WARNING: For safe and proper operation, the unit must be located a reasonable distance from combustible walls and materials. If safe distances are not maintained, discoloration or combustion could occur.

WARNING: To avoid electrical shock or personal injury, do not steam clean or use excessive water on the unit.

WARNING: If service is required on this unit, contact your authorized APW Wyott Service Agent, or contact the APW Wyott Service Department directly at (214) 421-7366 or (800) 527-2100; fax (214) 565-0976.

WARNING: This product has no "user" serviceable parts. To avoid damage to the unit or injury to personnel, use only Authorized APW Wyott Service Agents and genuine APW Wyott Parts when service is required.

WARNING: Genuine APW Wyott Replacement Parts are specified to operate safely in the environments in which they are used. Some aftermarket or generic replacement parts do not have the characteristics that will allow them to operate safely in APW Wyott equipment. It is essential to use APW Wyott Replacement Parts when repairing APW Wyott equipment. Failure to use APW Wyott Replacement Parts may subject operators of the equipment to hazardous electrical voltage, resulting in electrical shock or burn.

WARNING: The back and top surfaces of the unit will get hot. Use caution when touching these areas to avoid injury.

CAUTION: Locate the unit at the proper counter height, in an area that is convenient for use. The location should be level to prevent the unit or its contents from tipping over.

2. GENERAL INFORMATION

- Overall Dimensions w/Wire Feeder - 13.610"H (34.5cm) x 15.192"W (38.6cm) x 17.982"D (45.7cm)
- Product Opening - 1.50"H (3.8cm) x 10.50"W (26.7cm)
- Electrical Requirements (Single phase):
 - 120 Volt, 1800 Watt, 15 Amp.
 - 208 Volt, 1800 Watt, 8.5 Amp.
 - 230/240 Volt, 1800 Watt, 7.8 Amp.
 - Cordset configuration
 - Each toaster equipped with three wire grounded cordset and standard three-prong plug.
 - In the U.S.: 120V uses NEMA 5-15P. 208, 230/240V uses NEMA 6-20P.
 - In Canada: 120V uses NEMA 5-20P.
- Net/Shipping Weight – 28 lb.(12.7kg) / 33 lb.(14.97kg)

3. INSTALLATION INSTRUCTIONS

- Check Contents - refer to Figure 1, account for the following parts:
 - Wire Feeder - inside Reflector Tray
 - Reflector Tray - shipped in place
 - Toast Drawer - shipped in place
 - Instruction Manual - shipped loose
- Position Wire Feeder
 - Pull out Reflector Tray
 - Rotate Wire Feeder
 - Slide Reflector Tray back
 - WARNING:** Operating toaster without Reflector Tray reduces toasting capabilities.
- Toaster Placement
 - Locate toaster near a grounded receptacle of the proper configuration (see below). Plug the cordset directly into receptacle (**DO NOT USE AN EXTENSION CORD**).
 - In the U.S.: 120V uses NEMA 5-15R. 208, 230/240V uses NEMA 6-20R.
 - In Canada: 120V uses NEMA 5-20R.
 - Place toaster on flat surface providing following minimum clearances:
 - Base = one inch (provided with legs installed).
 - Side and back walls = two inches
 - Overhead = Enough space to allow adequate heat displacement.
 - Position toaster where customers will not contact any surface labeled "CAUTION HOT".

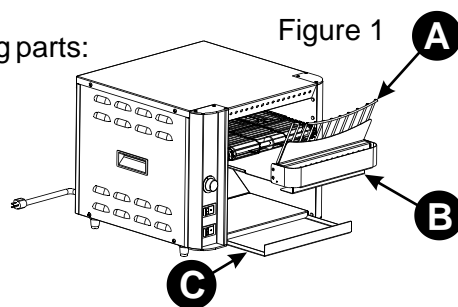

4. OPERATION INSTRUCTIONS

- Preparation
 - Clean toaster thoroughly before first use (See cleaning instructions).
 - Controls Familiarity
 - Main Power Switch (located on very bottom of control panel): There are two rocker switches. The bottom switch powers the unit "ON". It also turns on the bottom element. The top switch is a standby switch (upper heat switch) that runs the top element. When the standby switch is in the "ON" position the unit is at full power. When the standby switch is in the "OFF" position the unit is running at 50%.
 - Full Power: Flip both rocker switches to the right.
 - Power Off: Flip both rocker switches to the left.
 - Conveyor Speed Control: Set knob to the three (3) position for warm-up.
 - Warm-up time: Allow five (5) minutes.
- Normal Use
 - Loading Product
 - Place product on Wire Feeder. The conveyor will automatically draw product through the toaster at a speed determined by conveyor speed control.

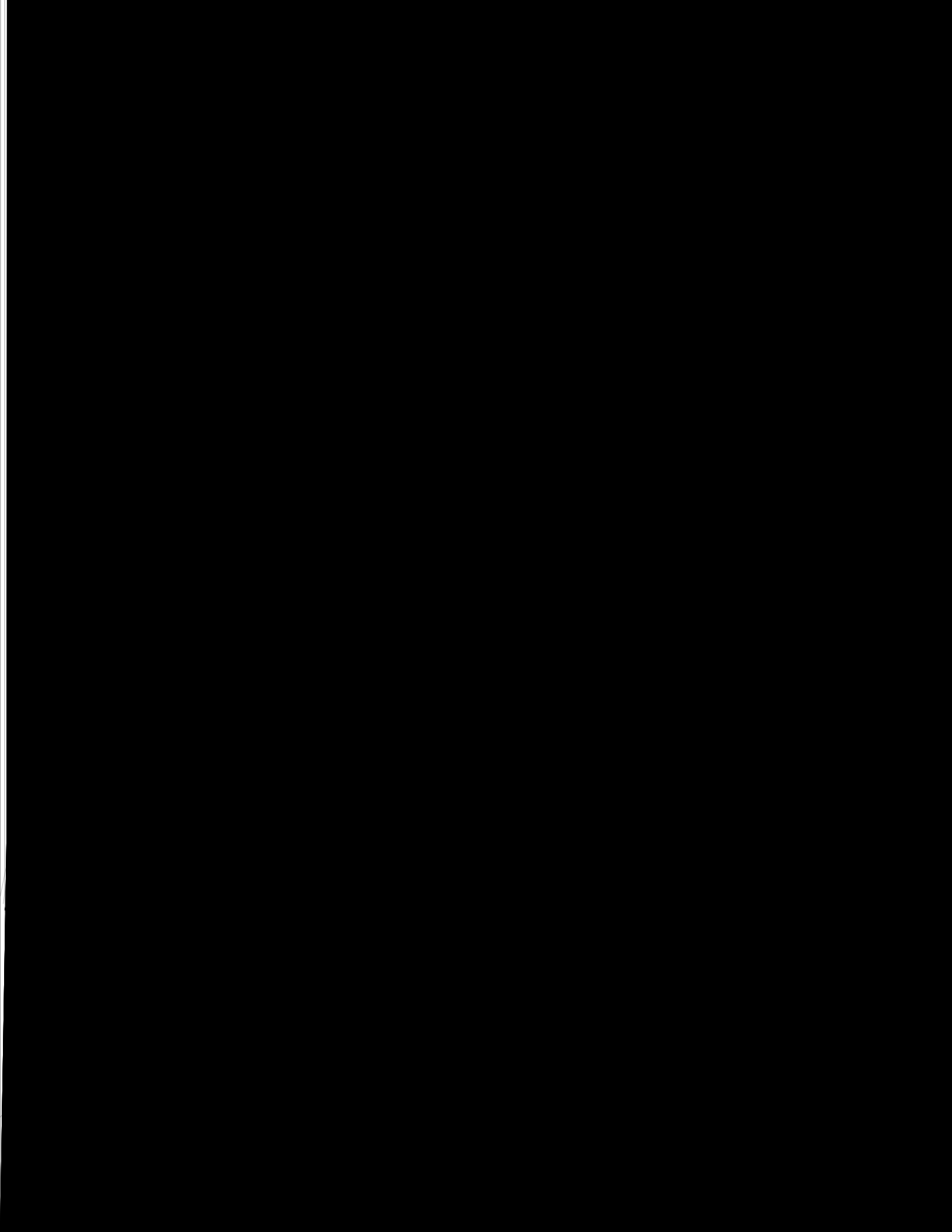

7. TROUBLESHOOTING

1. Always ask and check the following:
 - A. Is the unit connected to a live power source?
 - B. Check the circuit breaker.
 - C. Is power switch on?
 - D. Is the unit operating on proper voltage?
2. If problems exist after checking the above, check the chart below.
3. If any service is needed (*italicized items*), call an APW Wyott authorized service agency. All service should be performed by an APW Wyott authorized service agency.

PROBLEM	CAUSE	SOLUTION
Won't toast...	a. Toaster cold. b. Wrong power switch position. c. Wrong conveyor speed setting.	a. Allow five (5) minutes for warm up. b. Position power switch to full power. c. Reduce conveyor speed.
Toasts unevenly...	d. Only part of product surface is toasted. e. Product located too far to side of Conveyor.	d. Reduce conveyor speed. e. Place product on conveyor between End links.
Product sticks to conveyor or slide..	f. Butter or butter substitute used on product. g. Conveyor surface has baked-on oil residue. h. Very moist or doughy product. i. Product not defrosted or thawed.	f. Discontinue use of butter or butter substitute. g. Follow daily cleaning methods to remove & prevent residue. h. Use different source or day old product. i. Defrost/thaw product.
No power...	j. No power to receptacle. k. Toaster unplugged. <i>l. Loose connections.</i> m. Power switch.	j. Check circuit breaker. k. Plug in toaster. <i>l. Check connections.</i> m. Check that switch is on & operational.
Won't heat...	<i>n. Loose connections.</i> <i>o. Faulty power switch.</i> <i>p. Burnt out element.</i>	<i>n. Check connections.</i> <i>o. Replace power switch.</i> <i>p. Replace element.</i>
Lighter toast under peak loads...	q. Speed control setting. r. Very moist product. s. Product too cold. t. Toaster cavity temperature being quenched.	q. Reduce speed control setting. r. Use different source or day old product. s. Allow product to warm to room temperature. t. Add 1" or more spacing between product.
Conveyor won't Move...	u. No power. v. Conveyor links are binding. <i>w. Loose or bad connection between speed control and conveyor motor.</i> <i>x. Conveyor motor burnt out.</i> <i>y. Speed control burnt out.</i>	u. Check circuit breaker. v. Check conveyor for bent links. <i>w. Check for loose or bad connection.</i> <i>x. Replace conveyor motor.</i> <i>Y. Replace speed control.</i>

PARTS LIST

ITEM	PART NUMBER	DESCRIPTION	QUANTITY
1	93100158	RIVET ASSY, XPRS INNER CORE	1
2	93100160	XPRS-CONTROL PANEL EXTRUSION	1
3	93100162	XPRS-RIGHT SIDE EXTRUSION	1
4	93100150	XPRS-TOP COVER LEFT	1
5	93100061	XPRS-PANEL, LEFT OUTER	1
6	93100060	XPRS-PANEL, RIGHT OUTER	1
7	93000067	END CAP, F/L & B/R	2
8	93000070	END CAP, B/L & F/R	2
9	83267	LEG 1" PLASTIC W/CHROME	4
10	93100058	ASSY, XPRS FEEDER	1
11	93100101	WELD ASSY, XPRS-CONTROL PANEL	1
12	70444800	SWITCH, ROCKER ON-OFF	2
13	93100069	XPRS-BACK COVER	1
14	81600095	HANDLE, POCKET PULL SERIES	2
15	93100063	XPRS-PLATE, CONTROL PANEL	1
16	83221	RHEOSTAT, MOTOR CONTROL 120V	1
	83222	RHEOSTAT, MOTOR CONTROL 208, 230/240V	1
17	88705	KNOB 039-266 8A BLACK	1
18	38129	DRAWER TOAST	1
19	93100033	ASSY, ELEMENT HOLDER	2
20	54087	ELEMENT 120V 832W	2
	54088	ELEMENT 208V	2
	54089	ELEMENT 230/240V	2
21	93100047	XPRS-ELEMENT END CAP	4
22	89061	NUT, HEX 10-24	10
23	83248	BEARING, SHAFT	2
24	83821	BRACKET, BEARING	2
25	38130	ASSY, CLIP BEARING	2
26	38125	BEARING FLANGED POLYMER	2
27	38122	W'ASSY IDLER SHAFT	1
28	89184	BUSHING, .875 HEYCO 2126	1
29	85286	FAN MOTOR COOLING 120V	1
	85248	FAN MOTOR COOLING 208, 230/240V	1
30	85152	MOTOR AT10 115V 60HZ	1
	85149	MOTOR AT10 208/240V 60HZ	1
	85144	MOTOR AT10 230V 60HZ	1
31	89076	WASHER, LOCK 1/4 INTERNAL	4
32	89030	SCREW, 10-32X3/4	4
33	83209	SPROCKET, 23 TOOTH 1/4 PITCH 5/16 BORE	1
34	85287	FAN GUARD	1
35	83956	DRIVE SHAFT ASSY AT-10 SEGMENTED BELT	1
36	83261	SPROCKET, 12 TOOTH 1/4 PITCH 3/8 BORE	1
37	93100064	HEX MACHINE SCREW, #6-32 X 1/4	11
38	89073	SCREW, #8 X 1/2 HEX TAPIT SHT MTL TYPE AB	10
39	82902	CHAIN, 1/4" DRIVE 67 PITCH	1
40	89111	BUSHING, STRAIN RELIEF SR-7W-2	1
41	85638	CORDSET 14/3 600V 5-20P (120V)	1
	85640	CORDSET 14/3 600V 5-20P (230&240V)	1
42	PS0018	BELT, WIRE 27x.05 3 SEG.	1
43	89039	SCREW, 8-32X5/16 PH PAN SS	12
44	81600087	SCREW, 8-32 x 3/8, PHILLIPS, PAN HEAD	6
45	89063	NUT, HEX 8-32	4
46	83868	SPACER, CONVEYOR SHAFT	2
47	94000114	SCREW, COUNTERSINK, 6-32X5/16,Z,BLK	12
48	34236	TERMINAL BLOCK END MTG	1
49	34236	TERMINAL BLOCK END MTG	4
50	89054	NUT, KEPS 6-32	2

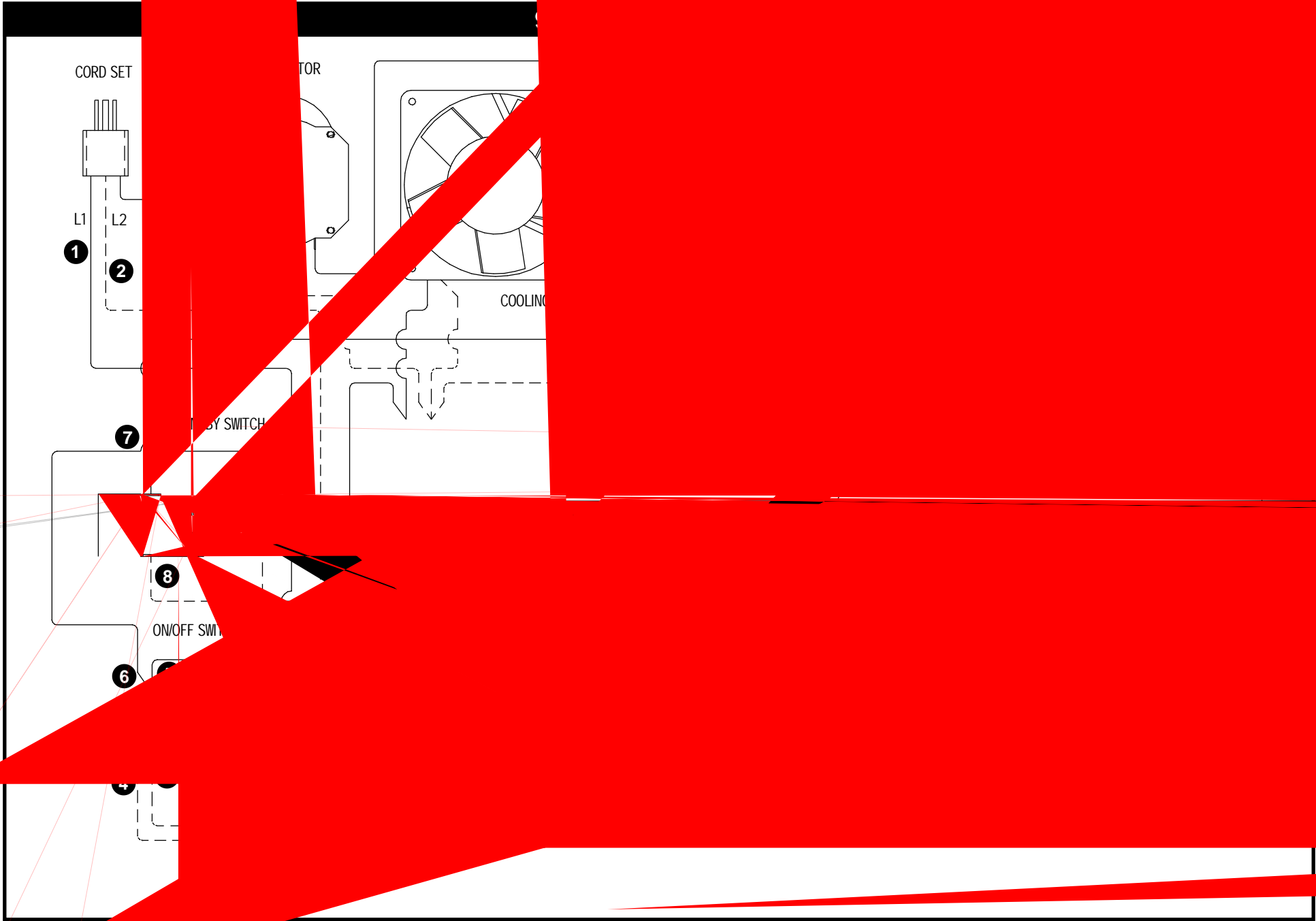

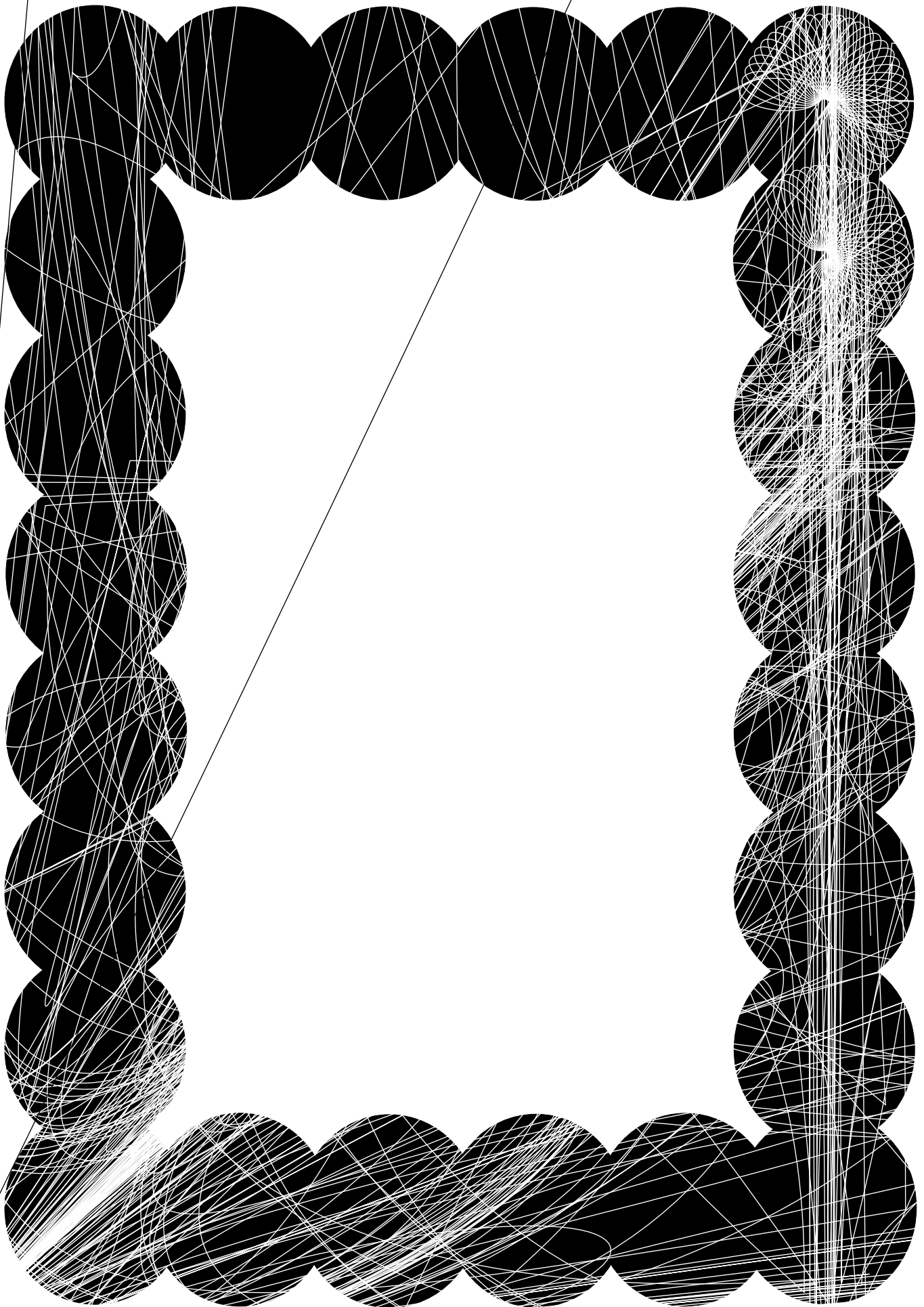



Phone: +1 (214) 421-7366
Fax: +1 (214) 565-0976
Toll Free: +1 (800) 527-2100
Website: www.apwwyott.com
E-mail: info@apwwyott.com

APW WYOTT
729 Third Avenue
Dallas, TX 75226